

A close-up, profile view of a man with dark, slicked-back hair and a well-groomed beard. He is wearing a dark, textured suit jacket over a white button-down shirt. The background is a plain, light-colored wall.

ON RITE[®]
Men's Collection
MEN'S HAIR DESIGN CATALOG

WORLD CLASS BASE DESIGN

Your clients have never
experienced **ANYTHING** like it!

AXIOM
STYLE DEFINED

Handcrafted utilizing reverse split knotting with light density for a natural look and a single-layer, ultra-soft woven lace base that will not fray when cut. Available in 44 natural colors including a full line of grey percentages.

Your clients turn to you for your expertise. We help keep them there.

HURRY!
WHILE SUPPLIES LAST.

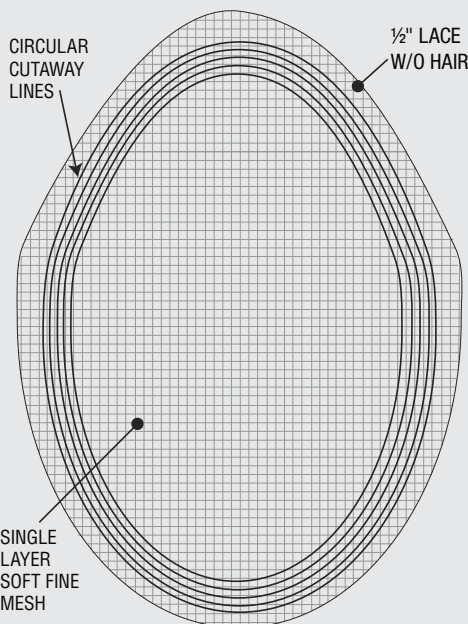

BASE DESIGN:

1/2" empty lace on front; single layer soft fine durable lace throughout with five circular rows of contour stitching. Material can be cut without fraying the edges.

STOCK SIZE: 8" x 10"

DENSITY: Light density (100%)
Maximum for custom is medium (130%).

LENGTH: 4" to 6"

DIRECTION: Freestyle

CURL: 30MM chemical perm

TYPE: Human hair

KNOTS: Reverse split knots

COLORS: Color ring #6165 see pages 16-17

LIFE: 6-8 SYSTEMS PER YEAR FOR
OPTIMAL RESULTS

PRESIDENT'S MESSAGE

On Rite Inc. [dba Hair Visions International] has proudly supported the hair replacement businesses with products, services, and education since 1975. The On Rite brand offers a large inventory of pre-made men's hair systems and specializes in custom designs.

On Rite is committed to providing the highest quality products and outstanding customer service. We will continue to innovate by creating new products, marketing, and business services that bring added value to our clients. We will also maintain an uncompromising commitment and passion for exceeding our customers' expectations daily.

Our guiding principle will always be to do the right thing, conduct ourselves honestly, and treat our clients with the utmost respect. Our success will always be measured by our customers' success! Thank you for your continued support through the years.

On Rite team members proudly look forward to providing you with the highest quality hair and accessories.

To view our latest collection of women's designs and human hair extensions, please ask for your free copy of our Gemtress, TressAllure, UltraTress, or accessories catalogs. Alternatively, you can download the digital versions directly from our site at: hairvi.co/hvicats

Oscar Urzola, President

PRODUCT INDEX

PRODUCT	PAGE	
Afro II	10	
Alan LM	9	
Axiom	Inside front cover	
Bella Moda Series	11	
Capri	Roma	Milano
Duplicator	12	
Echelon	2	
Edge Series	4	
Edge XT	Edge	Edge Lite
Edge Plus	Edge Lace	
Elán Series	5	
Elán-T	Elán-EZ	
Elán-SF	Elán-TF	
Elation	10	
Folligraft Series	2	
Folligraft II	Folligraft V	
Henry	6	
Omni Series	3	
OmniLite	OmniLace	
Ovation Series	6	
Ovation Human Hair		
Ovation Lace		
Patrick Series	7	
Patrick Human Hair	Patrick Synthetic	
Patrick Elite		
Permagraft Series	9	
PermaGraft I	PermaGraft IV	
PermaGraft III		
Razor	3	
Technograft Series	8	
TechnoGraft I	TechnoGraft III	
TechnoGraft II	TechnoGraft IV	
Trevor	12	
Versalite	3	
VIP	12	
MISCELLANEOUS		
Color Chart	16-17	
Hair Academy Education	15	
Jorgen Hair Care	13	
Perma Rite	14	

ECHELON

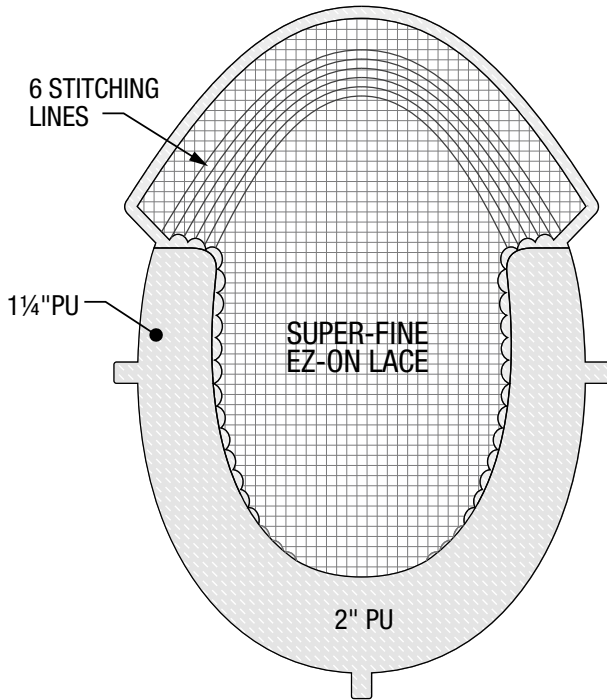

Size:	8" x 10"
Density:	Light to medium (115%)
Type:	Diamond Hair with synthetic grey
Length:	5" to 6"
Curl:	25mm
Colors:	Color ring #6165 see pages 16-17
Life:	4-6 systems per year for optimal results*

The first 3" of vented lace has undetectable knotting for a natural front appearance. The remainder of the base is a single layer construction of Super Fine EZ-On Lace connecting to a PU membrane with a small scalloping connection. Choices for attachment methods include perimeter or full-head bonding with ultimate cutaway options.

Human hair is the very best hand-selected Remy hair with a high denier shaft.

FOLLIGRAFT SERIES

HURRY!
WHILE SUPPLIES LAST.

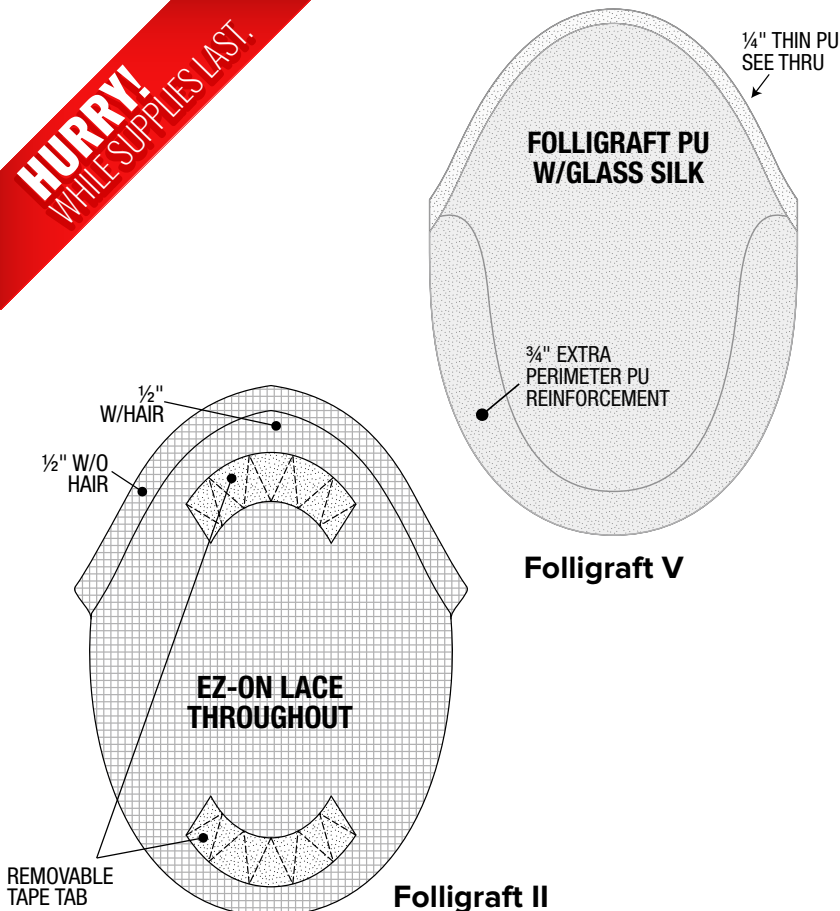

Size:	7" x 9"
Density:	Light to medium (115%)
Type:	100% human hair. Grey synthetic up to 50%. Extended greys available. See page 16.
Length:	4" - 6"
Curl:	28mm
Colors:	Color ring #6165 see pages 16-17
Life:	4-6 systems per year for optimal results*

The exclusive Java Knotting technique provides secure knots for the Folligraft series. When these grafts are applied to your client's scalp, they form a skintight fit without bumps or ridges, leaving them with only a full head of hair.

OMNI SERIES

EMPTY 1/2" ADDED TO FRONT

OmniLite

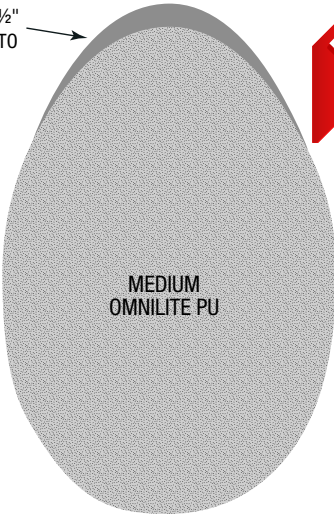

HURRY!
WHILE SUPPLIES LAST.

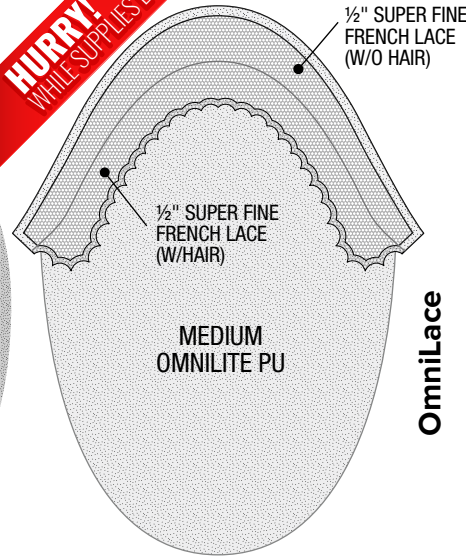

OmniLace

- Size:** OmniLite: 7" x 9" OmniLace: 7½" x 9½"
- Density:** **OmniLite:** Medium (130%) **OmniLace:** Light to medium (115%) in lace front. Medium (130%) rest of unit.
- Type:** 100% human hair. Grey synthetic up to 50%. Extended greys available. See page 16.
- Length:** 4" - 6"
- Curl:** 30mm
- Colors:** Color ring #6165 see pages 16-17
- Life:** 4-6 systems per year for optimal results*

Both models are constructed with medium OmniLite PU. The OmniLite has a scalloped #6 front while the OmniLace features a Super-Fine lace front. The reverse wet knot in the OmniLite PU provides a secure 360° freestyle. The lace front is ventilated with a small single knot for a natural hair line.

VERSALITE [REGULAR AND SMALL. ONLY SMALL IS BEING DISCONTINUED.]

HURRY!
WHILE SUPPLIES LAST.

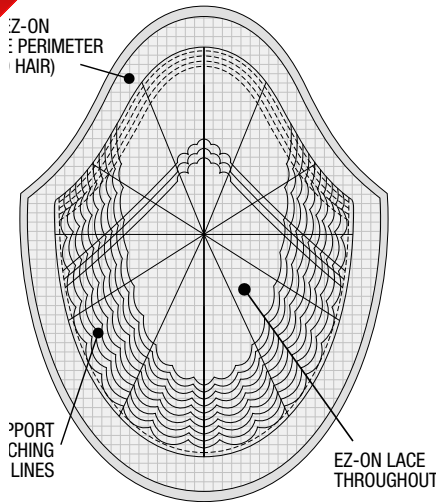

- Sizes:** **Regular** 7½" x 9½" | **Small** 6" x 8"
- Density:** Light to medium (115%)
- Type:** 100% human hair. Grey synthetic up to 50%. Extended greys available. See page 16.
- Length:** 4" - 6"
- Curl:** 30mm
- Colors:** Color ring #6165 see pages 16-17
- Life:** 4-6 systems per year for optimal results*

A single layer EZ-On Lace with base-reinforced stitching around the perimeter allows this graft to be easily cut to any size or shape.

Designed for a variety of attachment methods, Versalite is ideal for membership programs or daily wear.

RAZOR

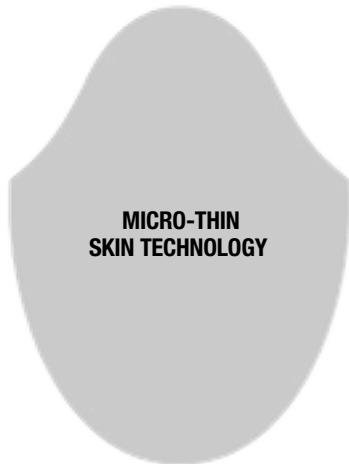

- Size:** 8" x 10"
- Density:** Extra light (80%)
- Type:** 100% human hair. Grey synthetic up to 50%. Extended greys available. See page 16.
- Length:** 4" - 6"
- Curl:** 25mm
- Colors:** Color ring #6165 see pages 16-17
- Life:** 12-18 systems per year for optimal results*

Micro-thin skin and V-Loop ventilation provides a more realistic look.

*Even though individual results cannot be guaranteed, we recommend the following guidelines for the optimal look.

EDGE SERIES

Size: 8" X 10"

Density: **LITE, LACE:** Light to medium (115%) **EDGE & PLUS:** Light (100%) **XT:** Extra Light (80%)

Type: 100% human hair. Grey synthetic up to 50%. Extended greys available. See page 16.

Length: **Lite, Lace, Edge & Plus:** 4½" - 5½" **XT:** 4" - 6"

Curl: **EDGE, PLUS, & XT:** 25MM, **LITE & LACE:** 28mm

Colors: Color ring #6165 see pages 16-17

EDGE LITE

8-12 SYSTEMS PER YEAR FOR OPTIMAL RESULTS*

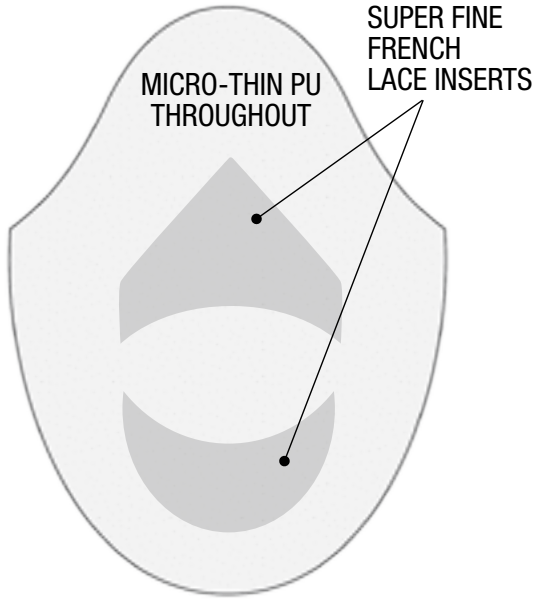

EDGE [V-Loop throughout]
12 SYSTEMS PER YEAR FOR OPTIMAL RESULTS*

EDGE PLUS [Single split knot & V-Looped front]
8-12 SYSTEMS PER YEAR FOR OPTIMAL RESULTS*

EDGE LACE (All Knotted)

8-12 SYSTEMS PER YEAR FOR OPTIMAL RESULTS*

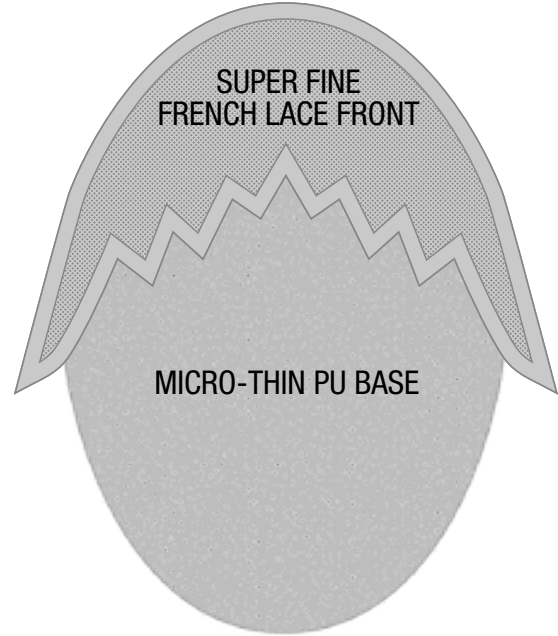

EDGE XT

12-18 SYSTEMS PER YEAR FOR OPTIMAL RESULTS*



ELÁN SERIES

Size: 8" x 10"

Density: Light density (100%), Elán-EZF is Light to medium (115%)

Type: 100% human hair. Grey synthetic up to 50%. Higher percentage grey blend see page 14. Except Elán-EZ and Elán-EZF: hair type is human hair with Endura grey. See page 16.

Length: 4" - 6" **Curl:** 25mm

Colors: Color ring #6165 see pages 16-17

Life: 6-12 systems per year for optimal results*

A very popular design that incorporates thin skin for a natural look.

ELÁN-SF 6-8 SYSTEMS PER YEAR FOR OPTIMAL RESULTS*

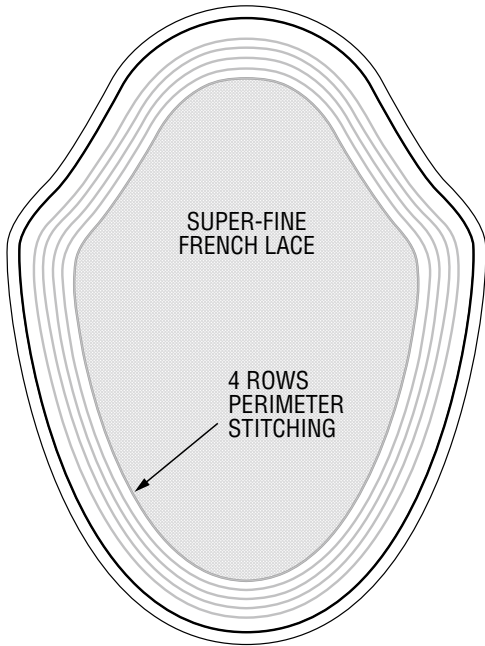

ELÁN-EZ 6-8 SYSTEMS PER YEAR FOR OPTIMAL RESULTS*

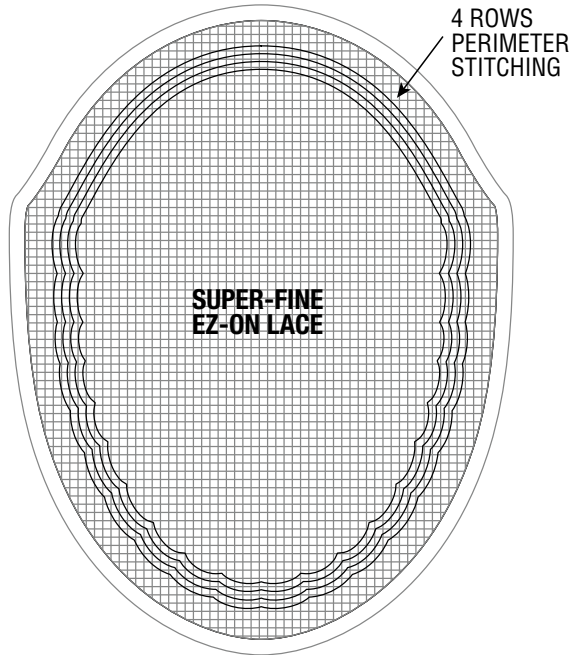

ELÁN-TF 8-12 SYSTEMS PER YEAR FOR OPTIMAL RESULTS*

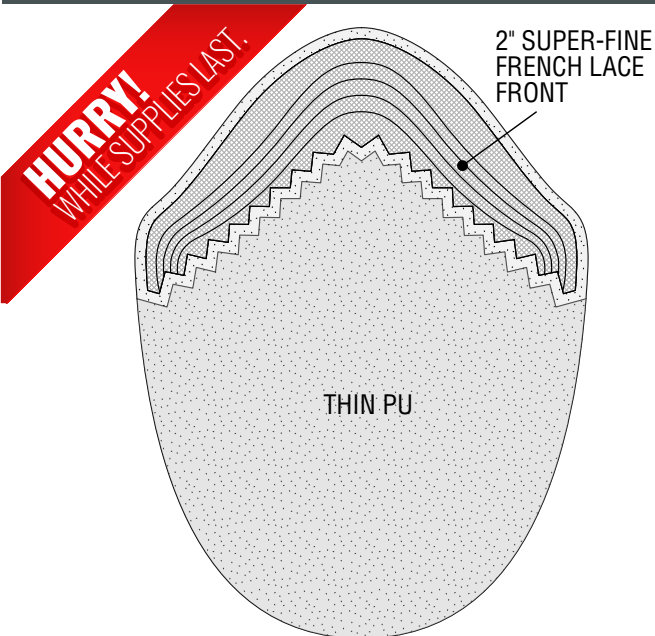

ELÁN-T: SPLIT KNOT 8-12 SYSTEMS PER YEAR FOR OPTIMAL RESULTS*

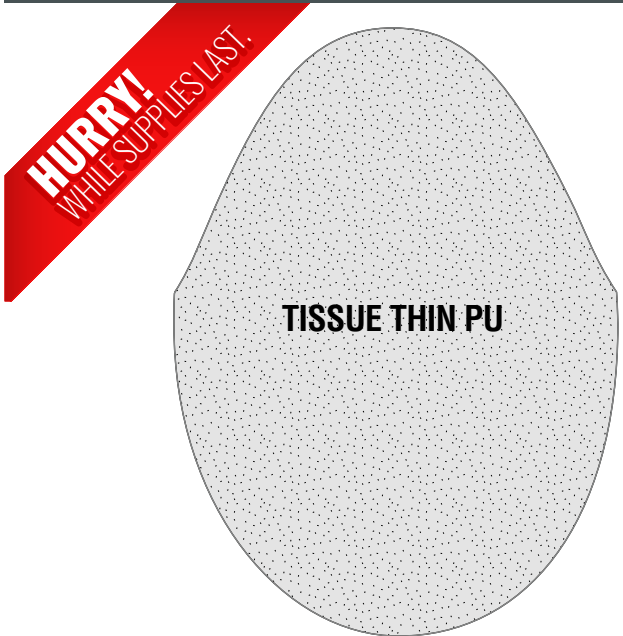

*Even though individual results cannot be guaranteed, we recommend the following guidelines for the optimal look.

OVATION

HURRY!
WHILE SUPPLIES LAST.

COMING SOON:
Ovation²

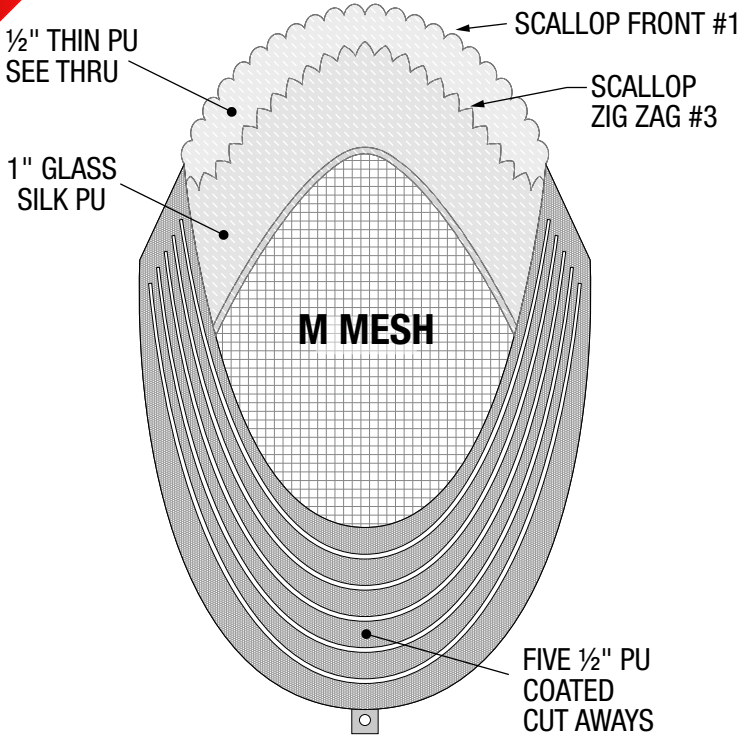

■ OVATION HH

Size: 8" x 10" **Density:** Medium (130%)

Length: 5-6" **Curl:** 25mm

Type: HH: Human hair with synthetic grey

Colors: Color ring #6165. See pages 16-17.

Life: 4-6 systems per year for optimal results*

■ OVATION LACE

Size: 8" x 10" **Density:** Medium (130%)

Length: 5-6" **Curl:** 25mm

Type: 100% human hair, synthetic grey up to 50%

Colors: Color ring #6165 see pages 16-17

Life: 6-8 systems per year for optimal results*

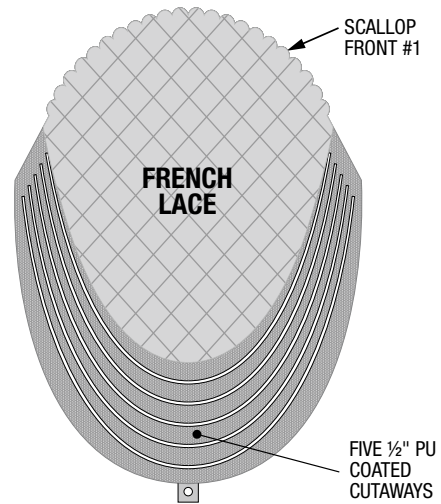

HENRY

HURRY!
WHILE SUPPLIES LAST.

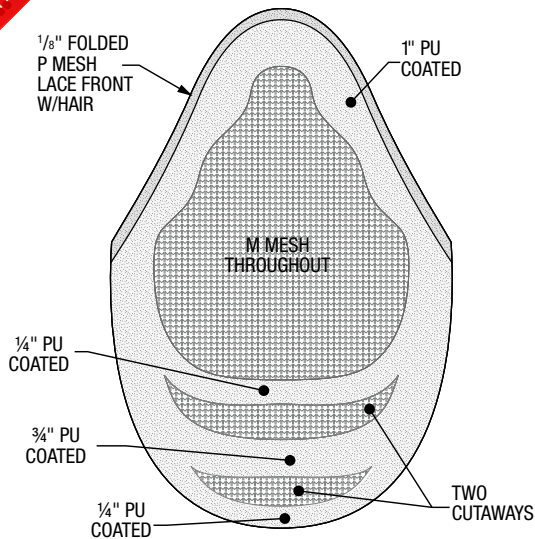

Size: 7 1/2" x 10 1/2"

Density: Medium to heavy (150%)

Type: Human hair with synthetic grey

Length: 4" - 6"

Curl: 25mm

Colors: Color ring #6165. See pages 16-17

Life: 4-6 systems per year for optimal results*

The Henry has the density needed for the client who wants thick hair. It has two cutaway options and will blend perfectly into your client's own hair.

PATRICK

The popular Patrick line is known for its combination of durability and believability.

Patrick Syn 2

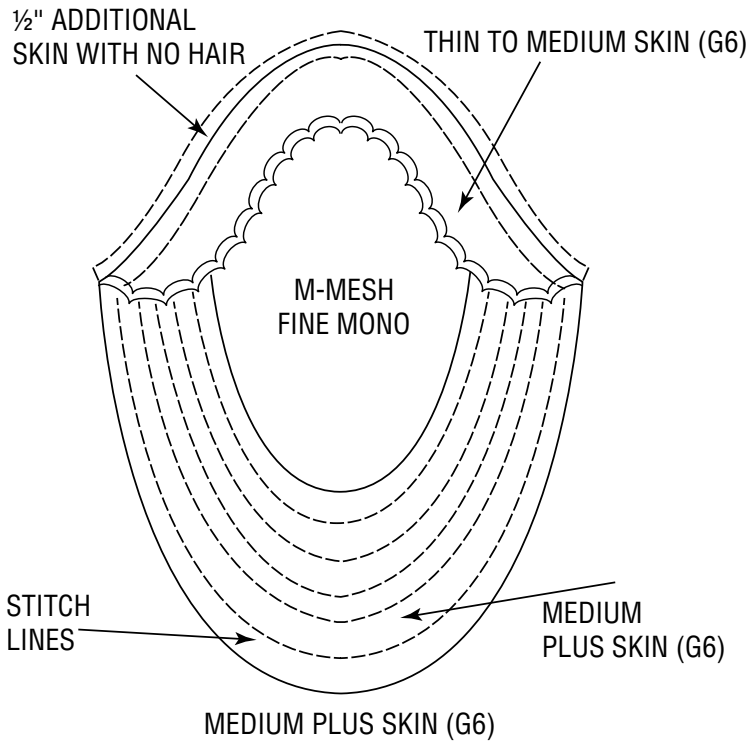

Patrick HH

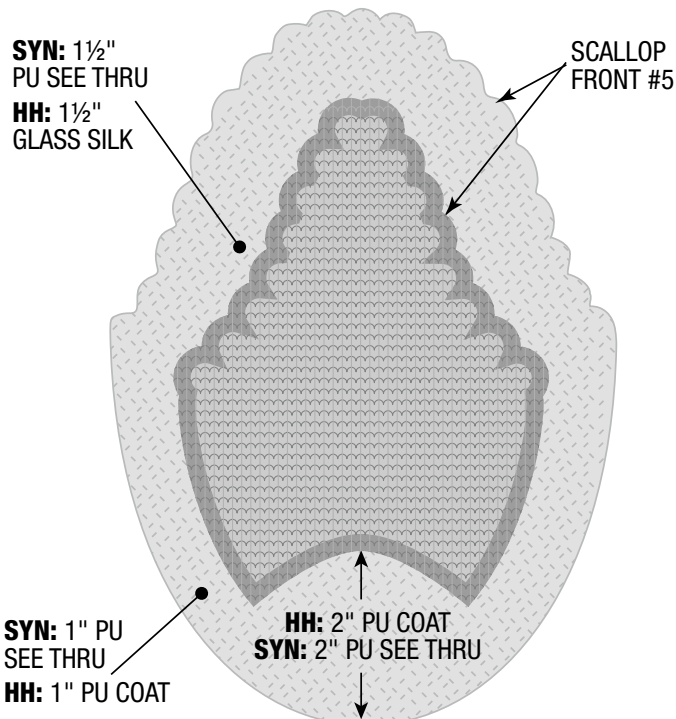

PATRICK HH OR SYN 2

Size:	7" x 9"
Density:	Medium (130%)
Type:	HH: 100% human hair. Grey synthetic up to 50%. Extended greys available. See page 14. Syn: Synthetic fiber
Length:	4" - 6"
Curl:	HH: 25mm Syn: 22-25mm
Colors:	HH: Color ring #6165. See pages 14-15. Syn: Synthetic color ring #1100. See pages 16-17.
Life:	4-6 systems per year for optimal results*

PATRICK ELITE

Size:	8" x 10"
Density:	Medium (130%)
Type:	100% human hair. Grey synthetic up to 50%. Extended greys available. See page 14.
Length:	4" - 6"
Curl:	25mm
Colors:	Color ring #6165 see pages 16-17
Life:	4-6 systems per year for optimal results*

The Patrick line features a scalloped front for a natural appearance. The Patrick human and Elite can be used as a daily wear for bonded applications. The Patrick synthetic is recommended for daily wear only.

The Patrick Elite is made with a French lace center and a thinner PU perimeter than the Patrick human hair. The design also is V-Looped in front.

Patrick Elite

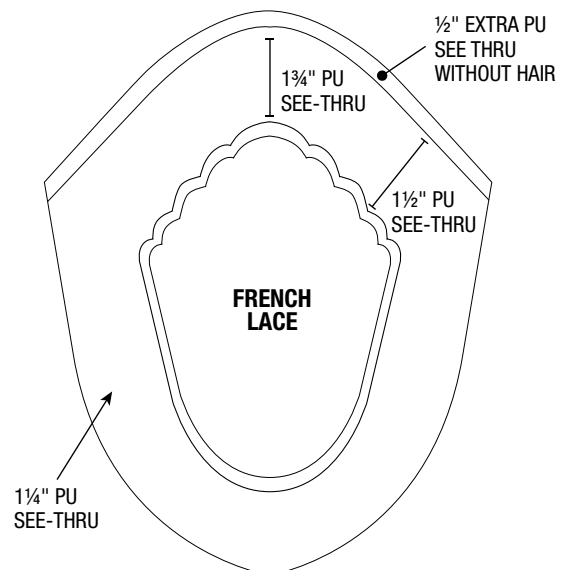

*Even though individual results cannot be guaranteed, we recommend the following guidelines for the optimal look.

TECHNOGRAFT SERIES SEE EACH RESPECTIVE PRODUCT FOR OPTIMAL RESULTS

Technograft I

For optimal results, we recommend 12-18 systems per year*

Thin PU throughout graduating to lighter weight in front.

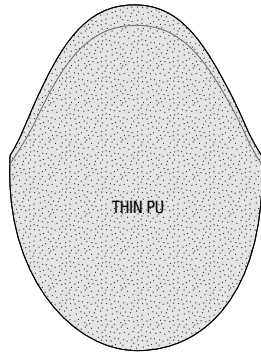

Size: 8" x 10" **Density:** Light to medium (115%)

Type: 100% human hair. Grey synthetic up to 50%.
Extended greys available. See page 16.

Length: 4" - 6" **Curl:** 25mm

Colors: Color ring #6165 see pages 16-17

Ventilation of the first three rows of hair are V-Looped for a realistic appearance.

Technograft II

For optimal results, we recommend 6-12 systems per year*

French Lace throughout with support stitching pattern.

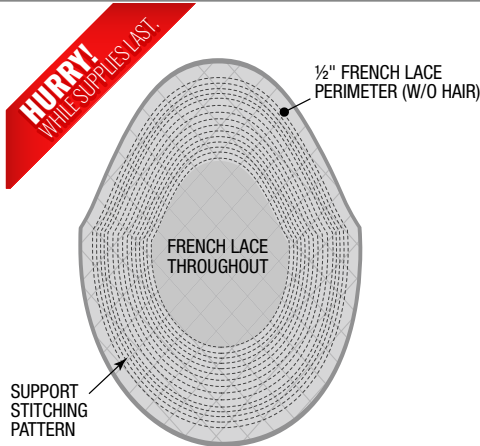

Technograft III

For optimal results, we recommend 8-12 systems per year*

Thin PU with four French Lace inserts in the center.

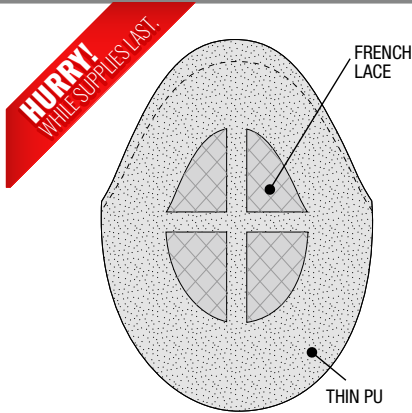

Technograft IV

For optimal results, we recommend 8-12 systems per year*

French Lace front, thin PU perimeter with four French Lace inserts.

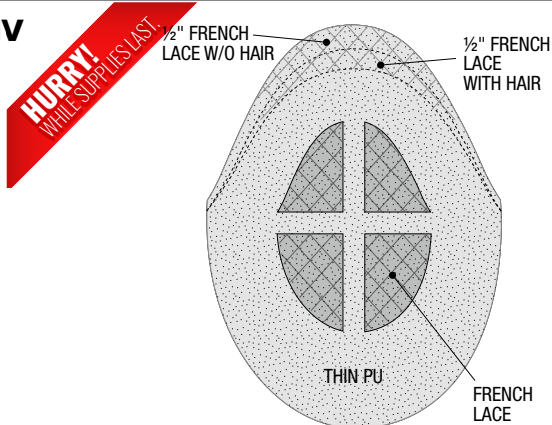

PERMAGRAFT SERIES

Size:	8" x 10"
Densities:	See product illustrations
Type:	Human hair with synthetic grey
Length:	4" - 6"
Curl:	25mm
Colors:	Color ring #6165 see pages 16-17
Life:	8-12 systems per year for optimal results*

The front hairline root areas of the Permagraft Series are lightened to be virtually undetectable. The ventilated hair direction is freestyle.

The first three rows of Permagraft I, III, and IV are V-Looped. Densities range from Light to medium (115%).

Permagraft I

Thin PU throughout, V-Looped in front. Density is light in sections 1, 3, 5 and Light to medium (115%) in section 2, 4 and 6.

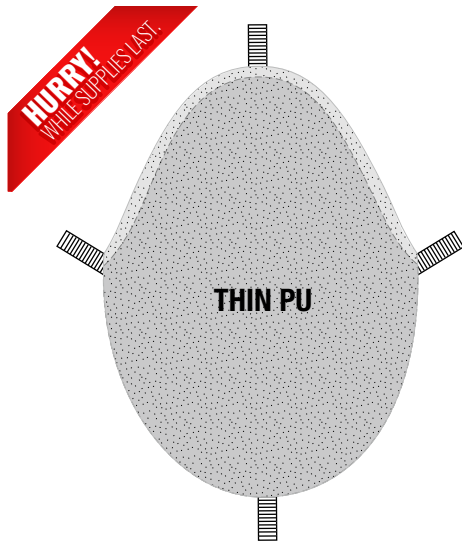

Permagraft III

Micro-thin PU throughout. V-Looped scallop front and Reverse Split Knots in other areas and Light to medium (115%) density throughout.

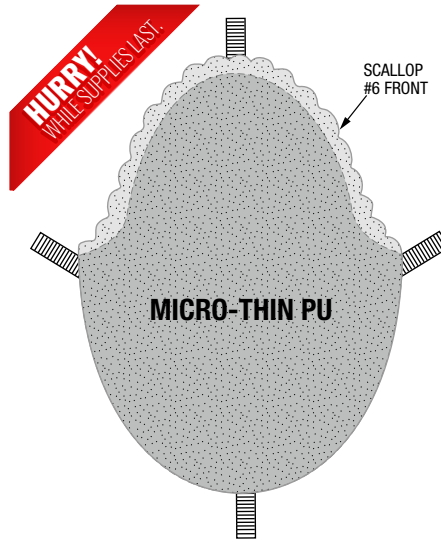

Permagraft IV

Micro-thin PU and a Super Fine EZ-On Lace in the center. Scallop front. Light to medium (115%) density throughout. V-Looped ventilation with Reverse Split Knot in other areas.

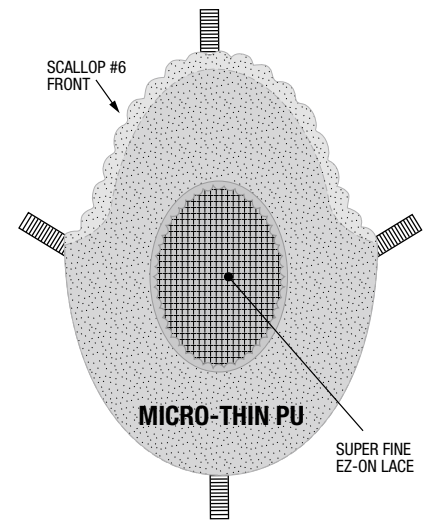

ALAN-LM

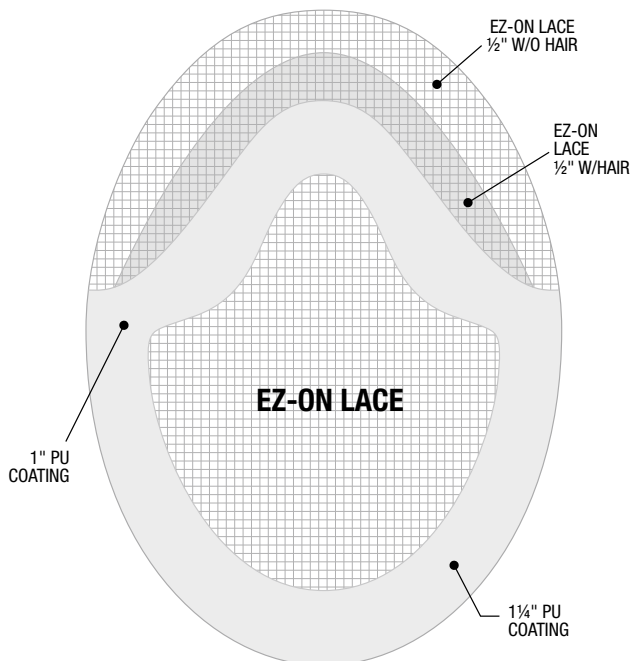

Size:	7 1/2" x 9 1/2"
Density:	Light to medium (115%) in the lace area, Medium (130%) in the rest of the unit
Type:	Human hair with synthetic grey
Length:	6"
Curl:	28mm
Colors:	Color ring #6165 see pages 16-17
Life:	4-6 systems per year for optimal results*

The Alan-LM combines conventional perimeter attachment designs with a lace front. There are multiple design possibilities as the lace front provides a more rounded hairline which can be altered to fit the hairline of any client. The Alan-LM can be clipped on, taped on, perimeter bonded, or grafted.

*Even though individual results cannot be guaranteed, we recommend the following guidelines for the optimal look.

AFRO II

Size:	7½" x 9½"
Density:	Light
Type:	Human hair with synthetic grey
Length:	2" to 2½"
Curl:	4mm chemically permed
Colors:	Color ring #6165 see pages 16-17
Life:	4-5 systems per year for optimal results.*

A single layer EZ-On Lace allows this graft to be cut to any size or shape without fuss or limitations to styling. Choices for attachment methods include taping, clipping, or full-head bonding.



Styling courtesy: www.WadeTheBarber.com

HURRY!
WHILE SUPPLIES LAST!

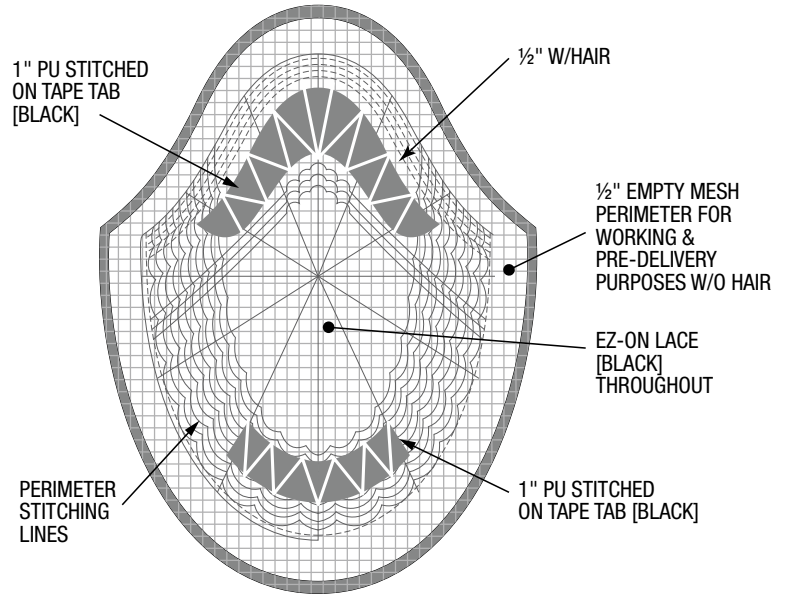

ELATION

Size:	8" x 10"
Density:	Light
Type:	Human hair with synthetic grey
Length:	2" to 2½"
Curl:	6mm chemically permed
Colors:	Color ring #6165 see pages 16-17
Life:	4-6 systems per year for optimal results.*

A durable medium PU base throughout with a #6 scalloped front edge, gives your client a natural hairline that is virtually undetectable, even when touched! Elation forms a skintight fit without any bumps or ridges.

HURRY!
WHILE SUPPLIES LAST!

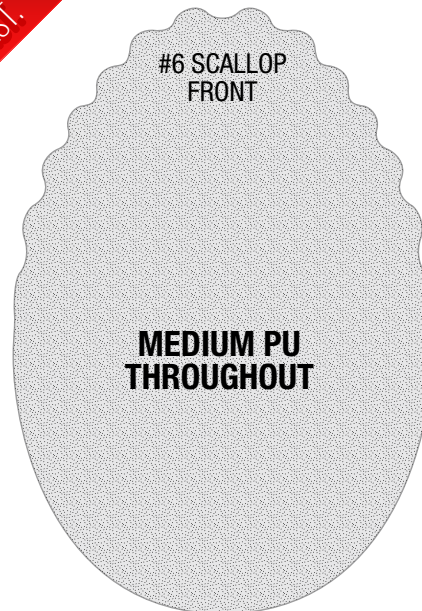

BELLA MODA SERIES

The Bella Moda series is constructed with a variety of base materials that deliver durability, a natural look with different recessions that meet all your clients' needs.

NAME	SIZE	DENSITY	LENGTH	CURL
Roma	7½" X 9½"	Light to medium (115%)	4" - 6"	25mm
Capri	7" X 9"	Light to medium (115%)	4" - 5"	25mm
Milano	7½" X 9½"	Light to medium (115%)	4" - 6"	25mm
Sorrento	7½" X 9½"	Light to medium (115%) in sections 1 and 3. Medium (130%) in sections 2, 4, 5, 6	4" - 6"	26mm

Type: Human hair with synthetic grey

Colors: Color ring #6165 see pages 16-17

ROMA 4-6 SYSTEMS PER YEAR FOR OPTIMAL RESULTS*

CAPRI 4-6 SYSTEMS PER YEAR FOR OPTIMAL RESULTS*

HURRY!
WHILE SUPPLIES LAST.

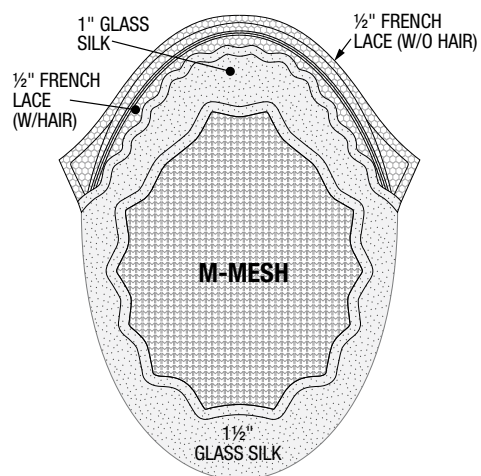
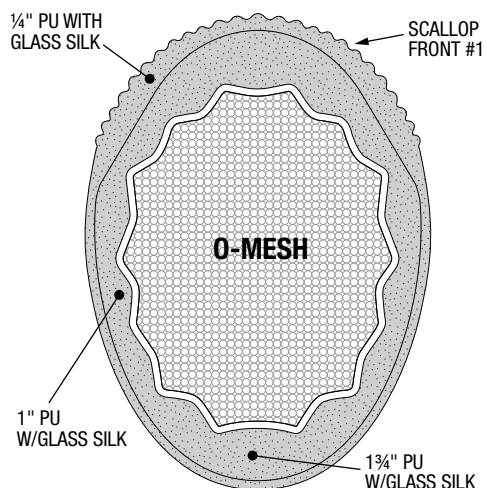

MILANO 6-8 SYSTEMS PER YEAR FOR OPTIMAL RESULTS*

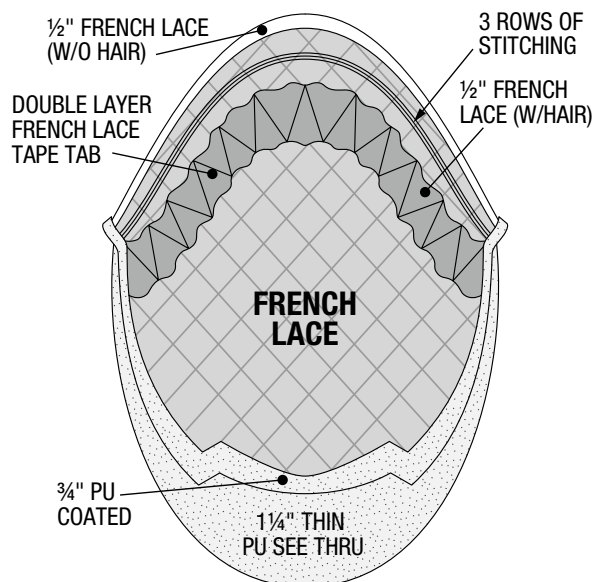

*Even though individual results cannot be guaranteed, we recommend the following guidelines for the optimal look.

HURRY!
WHILE SUPPLIES LAST.

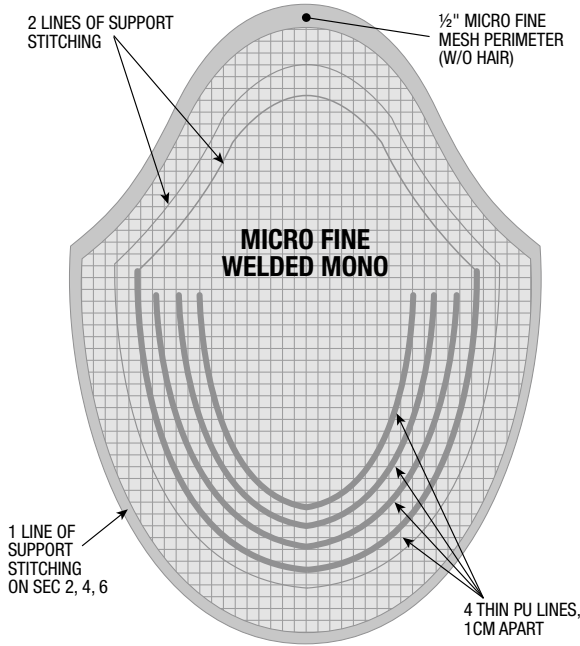

Size: 7 3/4" x 10 1/4"

Density: Light (100%)

Type: 100% human hair. Grey synthetic up to 50%. Extended greys available. See page 14.

Length: 4" - 6"

Curl: 28mm

Colors: Color ring #6165 see pages 16-17

Life: 6-8 systems per year for optimal results*

A multi-directional, light density men's hair graft designed with a single layer, micro-fine welded mesh base that virtually disappears into the scalp and looks incredibly natural.

FULL-CAP DESIGNS FOR TOTAL COVERAGE

Today's best technologies have been combined to create a comfortable and natural looking, form fitting full-cap. The durability you want, the security they need.

DUPLICATOR

6-8 SYSTEMS PER YEAR FOR OPTIMAL RESULTS*

Size: 21 1/2" circumference. Will stretch up to 23" circumference.

Density: Light to medium (115%)

Type: 100% human hair. Grey synthetic up to 50%. Extended greys available. See page 14.

Length: 4"

Curl: 28mm

Colors: Color ring #6165 see pages 16-17

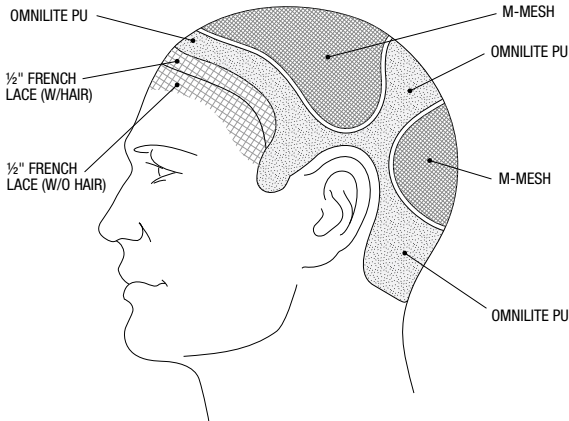

HURRY!
WHILE SUPPLIES LAST.

TREVOR

4-6 SYSTEMS PER YEAR FOR OPTIMAL RESULTS*

Size: 21 1/2" circumference

Density: Light to medium (115%) in sections #1, 2, 3, & 5 graduating to Medium (130%) in sections 4 & 6

Type: 100% human hair. Grey synthetic up to 50%. Extended greys available. See page 14.

Length: 4" on front graduating to 2" at sides and nape of neck

Curl: 25mm

Colors: Color ring #6165 see pages 16-17

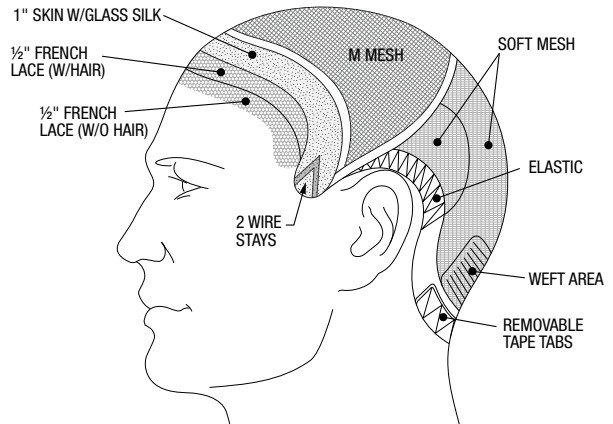

Jorgen

MEN'S
PREMIUM HAIR CARE

A UNIQUE APPROACH TO HAIR CARE FOR **EVERY HAIR TYPE**

Formulated using carefully selected ingredients balanced to provide optimum performance while keeping your client's hair looking great.



Jorgen products are **environmentally responsible** and are **not tested on animals**.

SHAMPOOS

SHAMPOO (8 OZ. 4233, QT. 4134)

Recommended for extended and daily wear as well as naturally growing hair. Gently cleanses the hair and helps protect the hair from color loss.

VOLUME PLUS SHAMPOO (8 OZ. 4243)

[For natural growing hair] A unique bodybuilding shampoo utilizing hydrolyzed yeast protein and magnesium which penetrates into the cortex of the hair shaft to deep condition and promote hair strength thus deterring hair loss.

MEDICATED SHAMPOO (8 OZ. 4240)

A non-alkaline medicated shampoo that is effective against dandruff. Prevents build-up which can cause scalp irritation and discomfort.

MOISTURIZING SHAMPOO (8 OZ. 4258)

Designed for natural normal, dry and damaged hair. Restores moisture to even the most damaged hair bringing it back to its natural luster and shine.

STYLING

FINISHING SPRAY (8 OZ. 4221)

Highly recommended to maintain a natural-looking hairstyle with a light hold and no excessive build-up. Contains sunscreen to provide protection from discoloration and fading.

SLEEK (8 OZ. 4221)

Strengthens hair while adding a healthy finished shine.

SCULPTING/HOLDING SPRAY (8 OZ. 4246)

Blended to correct and maintain proper moisture balance and holding strength. Added sunscreen protects the hair from damaging ultra-violet rays and oxidation.

WET LOOK LOTION (8 OZ. 4237)

Conditions hair while adding body and a styled wet look.

ULTRA HOLD GEL (8 OZ. 4267)

Perfect for dramatic effects, subtle curls, or high scrunch look. Retains moisture, increases shine and flexibility, while adding body with no flaking or dulling. Protects hair from damaging oxidation.

CONDITIONERS

CONDITIONER (8 OZ. 4227, QT. 4128)

Designed to penetrate and strengthen the hair shaft and helps eliminate tangling protecting the hair from breakage by adding body and luster.

LEAVE-ON CONDITIONER (8 OZ. 4206, QT. 4107)

Formulated to help eliminate tangles, making hair easier to style, while adding extra elasticity to prevent hair breakage.

PROTEIN CONDITIONER (8 OZ. 4249)

Oil-free deep treatment provides the hair with moisture, strength, shine and a proper pH-balance. Added sunscreen protects against damage.

MOISTURIZING CONDITIONER (8 OZ. 4261)

Softens and smoothes the cuticle layer restoring hair to its natural condition and shine.

MAINTENANCE

OXIDATION MAINTENANCE SPRAY (8 OZ. 4255)

Excellent because of its hydrolyzed human keratin content. When sprayed on wet hair, it will react like a styling lotion and help neutralize the peroxides remaining on the hair shaft.

RECONSTRUCTOR TREATMENT (8 OZ. 4264)

Formulated to rebuild and restore chemically damaged hair by repairing the hair shaft deep inside the cuticle restoring its natural shine and color.

RENEW (8 OZ. 4230)

Provides a clean, healthy, oil-free scalp for better hair graft adhesion.

WET CLEAN (8 OZ. 4215, QT. 4116)

[Use on synthetic fiber only.] Formulated to help hold knots longer and prevents slipping. Contains color guard that protects against discoloration and keeps your hair system fresh and clean.

ENHANCER (8 OZ. 4224)

[Use on synthetic fiber only.] Specially formulated to condition and prolong the body and luster of synthetic fibers.

AMBER SUPER SOLVENT (8 OZ. 4252, QT. 4153)

Removes most soft-bond medical adhesives from your client's scalp, hair, and hair graft.

BIO-ENZYME (8 OZ. 4269)

Spray-on, leave-in scalp cleaner and odor eliminator contains highly activated, non-pathogenic bacterial cultures that decompose and eliminate fats, oils, cellulose, and detergents leaving hair thoroughly clean.



Perma Rite
EXTREME XL 18:
Extreme bonding for your extreme clients.

Specially formulated for oily scalps, high humidity, and heavy perspiration.



Benefits of using Perma Rite Extreme XL 18:

Extra moisture protection:

Perma Rite Extreme XL 18 is specially formulated to resist moisture, making it ideal for use in humid or wet environments.

Higher melting point:

Perma Rite Extreme XL 18 has a higher melting point so it can withstand higher temperatures without melting or losing its bond strength.

800-327-5555



The best investment you can make in your studio is improving the quality of the work it produces.

Hair Academy®

The Hair Academy is excited to incorporate the highly successful CrossFit Hair Training curriculum developed by New Image.

HAIR ACADEMY X CROSSFIT INDUSTRY TRAINING

Takes your business to the next level. Unleash your potential with the ultimate training experience.

Now, more than ever before, we make education easier for you to achieve more for your business. The Hair Academy's CrossFit Educational Training prepares you and your staff to be the best in the hair replacement industry, PERIOD.

With the merger of two powerhouse businesses, we have created the ultimate training facility for business owners and hair stylists.

The CrossFit Educational curriculum provides training for every facet of your business. From consultations to delivery, we make education easier than ever, preparing you and your staff to not just meet but exceed industry standards.

Why Choose the Hair Academy X CrossFit Educational Training?

- **Unparalleled Expertise:** Learn from the best in the industry!
- **Flexibility On-Demand:** Attend our in-house training seminars at one of our state-of-the-art facilities in either West Palm Beach or Fort Lauderdale, Florida.
- **Cutting-Edge Technology:** Dive into intensive, hands-on training sessions that unveil the latest technology and products.

Grow your Business: Increase revenue from successful business owners.

Your Success Journey Begins Now!

COLOR CHART

PAGE	PRODUCT NAME	COLORS																																												
		1	1B	1B05	1B10	1B20	1B30	1B40	1B50	1B65	1B80	17	1710	1720	1740	1780	18	140	150	160	180	2	2A	20	2010	2080	205	205A	21	210	210A	220	220A	23	230	240	250	260	280	3	3A	305				
10	AFRO II	•	•	•	•	•		•													•																						•			
9	ALAN-LM	•	•		•	•					•	•		•		•	•		•			•		•	•					•	•		•		•		•						•			
1	AXIOM	•	•		•	•					•	•		•			•		•	•	•	•	•								•	•		•								•	•	•	•	•
11	CAPRI	•	•		•	•					•	•		•	•	•	•		•	•	•	•		•	•					•	•		•		•		•		•		•		•	•	•	
12	DUPLICATOR	•	•		•	•					•	•		•	•	•	•		•	•	•	•		•	•					•	•		•		•		•		•		•		•	•	•	
2	ECHELON	•	•		•	•					•	•		•	•	•	•		•	•	•	•		•	•					•	•		•		•		•		•		•		•	•	•	
4	EDGE	•	•	•	•	•	•		•		•	•		•	•	•	•		•	•	•	•	•	•			•	•	•	•	•	•	•	•	•	•	•	•	•	•	•	•	•	•	•	
4	EDGE PLUS	•	•	•	•	•	•		•		•	•		•	•	•	•		•	•	•	•	•	•			•	•	•	•	•	•	•	•	•	•	•	•	•	•	•	•	•	•	•	
4	EDGE LACE	•	•	•	•	•	•		•		•	•		•	•	•	•		•	•	•	•	•	•			•			•	•		•		•		•		•		•		•	•	•	
4	EDGE LITE	•	•	•	•	•	•		•		•	•		•	•	•	•		•	•	•	•	•	•			•			•	•		•		•		•		•		•		•	•	•	
4	EDGE XT	•	•	•	•	•	•	•	•		•	•		•	•	•	•		•	•	•	•	•	•			•			•	•		•		•		•		•		•		•	•	•	
5	ELAN-EZ	•	•		•	•					•	•		•	•	•	•		•	•	•	•	•	•					•	•		•		•		•		•		•		•	•	•		
5	ELAN-SF	•	•		•	•					•	•		•	•	•	•		•	•	•	•	•	•					•	•		•		•		•		•		•		•	•	•		
5	ELAN-T	•	•	•	•	•	•		•		•	•		•	•	•	•		•	•	•	•	•	•			•	•	•	•	•	•	•	•	•	•	•	•	•	•	•	•	•	•	•	
5	ELAN-TF	•	•		•	•					•	•		•	•	•	•		•	•	•	•	•	•					•	•		•		•		•		•		•		•	•	•		
10	ELATION	•	•		•	•	•	•																																						
2	FOLLIGRAFT II	•	•		•	•					•	•		•	•	•	•		•	•	•	•	•	•					•	•		•		•		•		•		•		•	•	•		
2	FOLLIGRAFT V	•	•		•	•					•	•		•	•	•	•		•	•	•	•	•	•			•			•	•		•		•		•		•		•		•	•	•	
6	HENRY	•	•		•	•					•	•		•	•	•	•		•	•	•	•	•	•					•	•		•		•		•		•		•		•	•	•		
11	MILANO	•	•		•	•					•	•		•	•	•	•		•	•	•	•	•	•					•	•		•		•		•		•		•		•	•	•		
3	OMNILACE	•	•	•	•	•	•		•		•	•		•	•	•	•		•	•	•	•	•	•			•			•	•		•		•		•		•		•		•	•	•	
3	OMNILITE	•	•	•	•	•	•		•		•	•		•	•	•	•		•	•	•	•	•	•			•			•	•		•		•		•		•		•		•	•	•	
6	OVATION	•	•	•	•	•	•		•		•	•		•	•	•	•		•	•	•	•	•	•			•			•	•		•		•		•		•		•		•	•	•	
6	OVATION LACE	•	•		•	•					•			•	•	•	•		•	•	•	•	•	•					•	•		•		•		•		•		•		•		•	•	•
7	PATRICK HH	•	•	•	•	•	•		•		•	•		•	•	•	•		•	•	•	•	•	•			•			•	•		•		•		•		•		•		•	•	•	
7	PATRICK ELITE HH	•	•		•	•					•	•		•	•	•	•		•	•	•	•	•	•					•	•		•		•		•		•		•		•	•	•		
7	PATRICK SYN	•	•		•	•					•	•		•	•	•	•		•	•	•	•	•	•			•			•	•		•		•		•		•		•		•	•	•	
9	PERMAGRAFT I	•	•		•	•					•	•		•	•	•	•		•	•	•	•	•	•					•	•		•		•		•		•		•		•	•	•		
9	PERMAGRAFT III	•	•		•	•					•	•		•	•	•	•		•	•	•	•	•	•					•	•		•		•		•		•		•		•	•	•		
9	PERMAGRAFT IV	•	•		•	•					•	•		•	•	•	•		•	•	•	•	•	•					•	•		•		•		•		•		•		•	•	•		
3	RAZOR	•	•	•	•	•	•		•		•	•		•	•	•	•		•	•	•	•	•	•			•			•	•		•		•		•		•		•		•	•	•	
11	ROMA	•	•		•	•					•	•		•	•	•	•		•	•	•	•	•	•					•	•		•		•		•		•		•		•	•	•		
8	TECHNOGRAFT I	•	•		•	•					•	•		•	•	•	•		•	•	•	•	•	•					•	•		•		•		•		•		•		•	•	•		
8	TECHNOGRAFT II	•	•		•	•					•	•		•	•	•	•		•	•	•	•	•	•					•	•		•		•		•		•		•		•	•	•		
8	TECHNOGRAFT III	•	•		•	•					•	•		•	•	•	•		•	•	•	•	•	•					•	•		•		•		•		•		•		•	•	•		
8	TECHNOGRAFT IV	•	•		•	•					•	•		•	•	•	•		•	•	•	•	•	•					•	•		•		•		•		•		•		•	•	•		
12	TREVOR	•	•		•	•					•	•		•	•	•	•		•	•	•	•	•	•					•	•		•		•		•		•		•		•	•	•		
3	VERSALITE	•	•	•	•	•	•		•		•	•		•	•	•	•		•	•	•	•	•	•					•	•		•		•		•		•		•		•	•	•		
3	VERSALITE-S	•	•		•	•					•	•		•	•	•	•		•	•	•	•	•	•					•	•		•		•		•		•		•		•	•	•		
12	VIP	•	•		•	•	•		•		•	•		•	•	•	•		•	•	•	•	•	•					•	•		•		•		•		•		•		•	•	•		

*Even though individual results cannot be guaranteed, we recommend the following guidelines for the optimal look.

ON RITE®
(d.b.a. Hair Visions International)

1-800-327-5555 • Fax: (954) 677-0505
www.HairVisionsIntl.com • e-mail: info@HairVisionsIntl.com

© 2024 On Rite d.b.a. Hair Visions International. All rights reserved. All artwork, images and photography contained in this catalog including the copyrights therein, are protected by law and may not be copied or reproduced in whole or in part without prior written permission from On Rite Co., Inc.

Follow us on social media:
www.instagram.com/onrite_
www.facebook.com/HairVisionsInternational